

# Comparative Study of Magnetic Pc-Type Pulsations between the Low-Latitudes and the High-Latitudes (I)

## —Statistical Features of Pc 1 Pulsations—

by

Takeshi TOYA, Masayuki KUWASHIMA and Makoto KAWAMURA  
(Kakioka Magnetic Observatory)

and

Hiroshi FUKUNISHI and Masaru AYUKAWA  
(National Institute of Polar Research)

### Abstract

Statistical features of Pc 1 pulsations were studied on the basis of data obtained at a low-latitude station, Memambetsu in Japan and at a high-latitude station, Syowa Station in Antarctica for the period of February, 1977 to January, 1978. The low-latitude Pc 1 shows marked differences from the high-latitude one in diurnal and seasonal variations of frequency of occurrence, mean and repeating periods, and dependencies on general geomagnetic activity (Dst and Kp). The source region associated with the low-latitude Pc 1 seems to be located more earthward in the magnetosphere than that associated with the high-latitude one.

### 1. Introduction

In accompany with the development of the magnetic tape recording system and the dynamic spectral analysis system, Pc 1 pulsations (0.2-5 sec in period) have been analyzed by many research workers after IGY (Saito, 1960; Heacock and Hessler, 1962; Kato and Saito, 1964; Troitskaya, 1967; Kawamura, 1970; Kokubun, 1970). At low-latitudes, Pc 1 pulsations can be divided into two main subtypes: pulsation pearl and continuous emission (Kawamura, 1970). The former is characterized by a repeated structure with bouncing period of about 2~3 min showing a fan shape in its dynamic spectrum. The latter is characterized by a continuous dynamic spectrum without any repeated structure. At high-latitudes, many subtypes of Pc 1 pulsations are observed. According to the results by Kokubun (1970), they are HM whistler (corresponding to pearl pulsation at low-latitudes), periodic HM emission, HM chorus (corresponding to continuous emission at low-latitudes) and sweeper. However, the global characteristics of Pc 1 have not yet been clarified. Especially, the relation between the low-latitude Pc 1 and the high-latitude one has not yet been studied sufficiently.

Different types of diurnal variation of frequency of occurrence have been reported by many research workers (Benioff, 1960; Schlich, 1963; Kato and Saito, 1964; Fraser,

1965; Heacock and Hessler, 1965; Troitskaya, 1967; Kokubun and Oguti, 1968; Kawamura, 1970). They are summarized as follows: Pc 1 occurrence maximum time is in the daytime at high-latitudes, whereas it is mostly in the nighttime at low-latitudes. The maximum times seem to shift gradually from the daytime to the nighttime at about  $60^\circ$  in geomagnetic latitude. However, the above-mentioned confusion could be arisen from differences in observing apparatus and analyzing intervals. It is necessary to obtain data by means of similar observing apparatus and analyze them at common intervals for a comparison of Pc 1 characteristics between at low-latitudes and at high-latitudes. The purpose of this paper is to study the statistical characteristics of Pc 1 on the basis of the data obtained at a low-latitude (Memambetsu) and at a high-latitude (Syowa Station). Similar observing apparatus are installed at the two stations.

In Section 2, we will show the observing and analyzing method of Pc 1 pulsations. Several representative Pc 1 events will be shown in Section 3 (low-latitude) and Section 4 (high-latitude). In Section 5, we show two Pc 1 events which were simultaneously observed over the wide area from the high-latitude through the low-latitude. The statistical features of Pc 1 will be compared between the low-latitude and the high-latitude in Section 6 (for occurrence frequency) and in Section 7 (for dependence on general geomagnetic activity). In Section 8, we will summarize the results derived in the present analysis and give some interpretations.

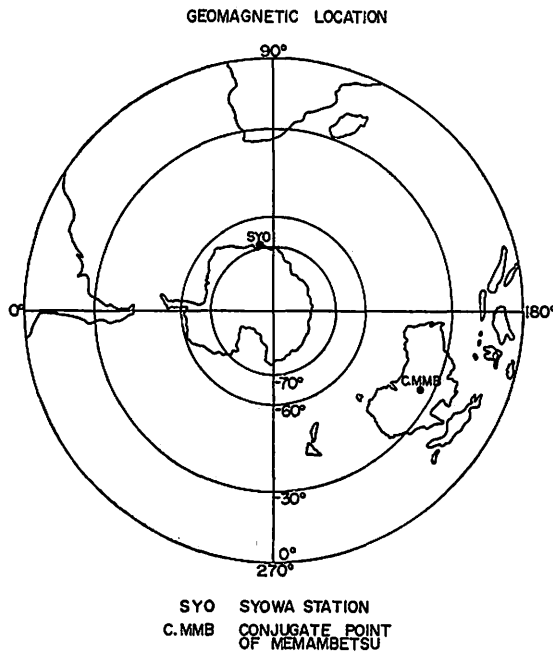

Fig. 1. Geomagnetic locations of Memambetsu in Japan and Syowa Station in Antarctica.

2. Experiment and data analysis

In the IMS (International Magnetospheric Study) period, we have carried out concurrent observations of magnetic pulsations at our low-latitude Japanese stations: Memambetsu, Kakioka, Kanoya and Chichijima since January, 1976. On the other side, concurrent observations of magnetic pulsations were carried out at Syowa Station and Mizuho Stations in Antarctica during the period of February, 1977 to January, 1978 by the 18th wintering party of the Japanese Antarctic Research Expedition. Two of the present authors, Toya and Ayukawa, were members of that party. In this paper, data from Memambetsu and from Syowa are used for the study of low-latitude and high-latitude Pc 1 events, respectively. Memambetsu ( $43^{\circ}55'N$ ,  $144^{\circ}12'E$  in geographic coordinates) is a representative low-latitude station and is located at latitude  $34.0^{\circ}$  and longitude  $208.4^{\circ}$  in geomagnetic coordinates. Syowa Station ( $69^{\circ}00'S$ ,  $39^{\circ}35'E$  in geographic coordinates) is also a representative auroral

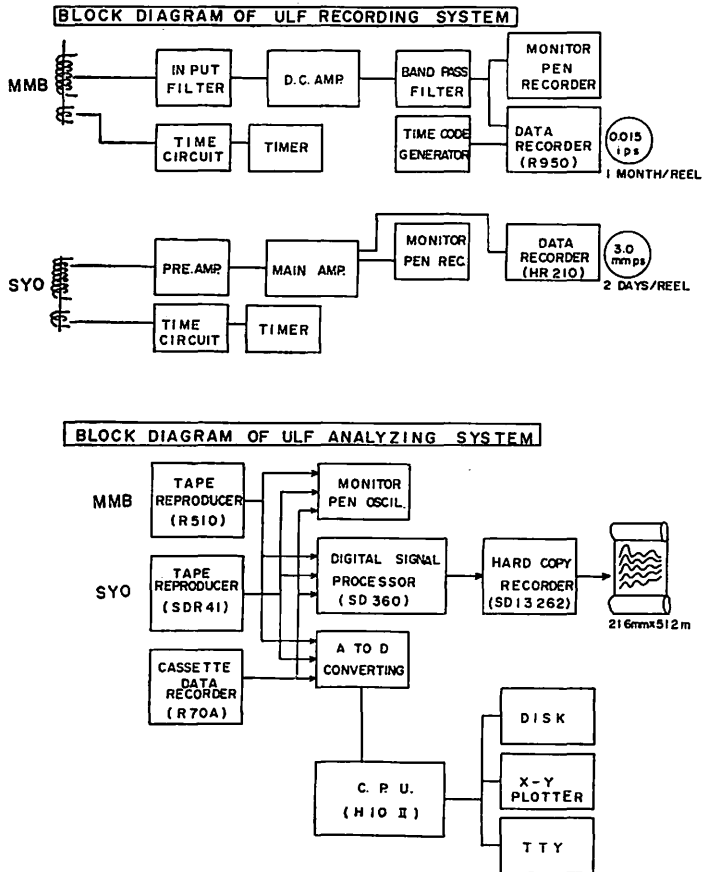

Fig. 2. ULF observing systems installed at Memambetsu (a) and Syowa Station (b), and ULF analyzing system installed at Kakioka (c).

station and is located at latitude  $-66.7^\circ$  and longitude  $72.4^\circ$  in corrected geomagnetic coordinates. The locations of these two stations are shown in Fig. 1. For a study of diurnal variations for Pc 1 pulsations, we use local time (LT) at Memambetsu and magnetic local time (MLT) at Syowa, their relations to UT being  $LT \sim UT + 9h$  and  $MLT \sim UT$ , respectively.

We show ULF observing systems installed at Memambetsu and Syowa, and ULF analyzing system installed at Kakioka in Fig. 2. The ULF observing system installed at Syowa is essentially equivalent to that at Memambetsu. Magnetic pulsations were observed by means of the induction magnetometer for  $X$ ,  $Y$  and  $Z$  components at Memambetsu, while for  $H$ ,  $D$  and  $Z$  components at Syowa. Main parts of the induction magnetometer are sensors, D.C. amplifiers, a magnetic tape recorder and a monitoring pen recorder. Details of the observing system should be referred to Kawamura and

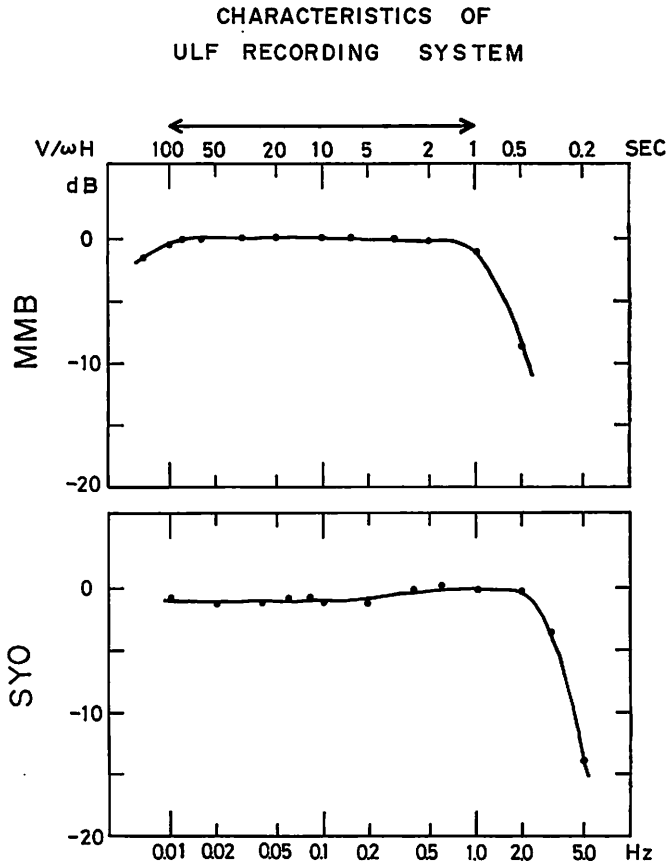

Fig. 3. Frequency (period) characteristics of ULF observing system at Memambetsu (a) and Syowa Station (b). They are compatible with each other at the two stations in period range from 1 to 100 sec.

Kuwashima (1977) concerning the system at Memambetsu and also should be referred to Kuwashima (1978) concerning that at Syowa. Total frequency (period) characteristics of the observing system are illustrated in Fig. 3. It is evident in the figures that the observed phenomena are compatible with each other at the two stations in period range from 1 to 100 sec. We treat Pc 1 events in period ranging from 1 to 10 sec in the present analysis.

Data recorded on a magnetic tape are stepped up with ultra high speed ( $\times 4000$  for example) by a tape reproducer. And then, they are analyzed by means of a dynamic spectrum analyzer, which executes spectrum analysis in a Fast Fourier Transform method. Details for this analyzer and examples of several kinds of analyzed data have been reported by Kawamura (1977).

### 3. Examples of Pc 1 event observed at low-latitudes

Two representative examples of Pc 1 pulsations observed at the low-latitude station, Memambetsu, are shown in Figs. 4(a) and (b). Pulsation pearl type (pp) events are seen during the interval of 1408-1638 UT on April 11, 1977 (Fig. 4(a)). As is shown in the figure, PP has two characteristic periods, namely, mean period and repeating period. In the event of Fig. 4(a), the mean period gradually increases from  $\sim 1.3$  sec ( $\sim 1430$  UT) to  $\sim 2.0$  sec ( $\sim 1630$  UT). According to the results by Heacock and Hessler (1962), and Gendrin (1963), mean period  $T_m$  is roughly proportional to repeating period  $T_r$ , and is expressed as  $T_r = 86 T_m$ . Such a relation is also seen in Fig. 4(a), in which repeating periods are  $\sim 1.5$  min and  $\sim 2.5$  min at  $\sim 1430$  ( $T_m = \sim 1.3$  sec) and at  $\sim 1630$  ( $T_m = \sim 2.0$  sec), respectively.

Contrary to the former example, the mean period gradually decreases from  $\sim 1.9$  sec ( $\sim 0850$  UT) to  $\sim 1.0$  sec ( $\sim 1030$  UT) in the event on April 7, 1977. However, the relation of repeating period with mean one is similar to the former example. The former (the latter) is 2.0 min (1.3 sec) at  $\sim 0915$  UT.

### 4. Examples of Pc 1 event observed at high latitudes

Fig. 5 shows a representative Pc 1 event observed at the high-latitude station, Syowa. In the figure, PP events were observed during the interval of 1035-1400 on April 18, 1977. The mean period in this event gradually increases with time: 2.4 sec at 1040 and 3.6 sec at 1350 UT. Pc 1 mean periods observed at the high-latitude are somewhat longer than those at the low-latitude. Pc 1 repeating periods in Fig. 5 range from  $\sim 3.5$  min to  $\sim 5.0$  min and are also longer than those in Figs. 4(a) and (b).

Another representative Pc 1 event at high-latitude is shown in Fig. 6, in which PP events were observed continuously over 5 hours (0640-1200 UT on May 9, 1977). In this event, the increase of mean period from  $\sim 2$  sec to  $\sim 3$  sec and the associated increase of repeating periods from  $\sim 3.0$  min to  $\sim 4.5$  min are very clearly seen. Mean and repeating periods observed at the high-latitude are longer than those at the low-latitude in this event, too.

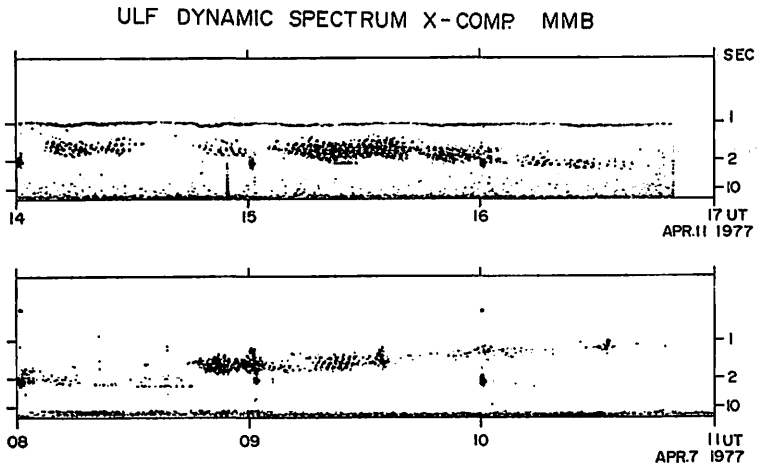

Fig. 4. Dynamic spectra of pearl pulsation type Pc 1 event observed at Memambetsu on April 11 (a) and April 7 (b), 1977. In the spectra, fan structures are clearly seen.

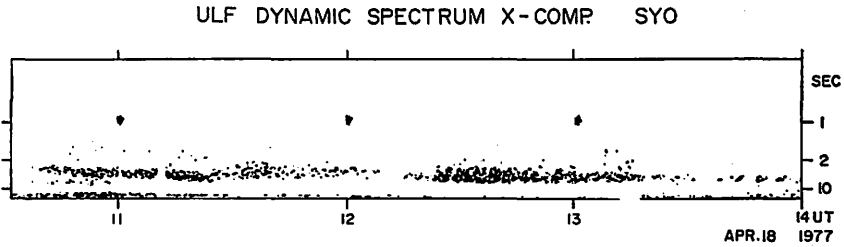

Fig. 5. Dynamic spectrum of Pc 1 event observed at Syowa on April 18, 1977.

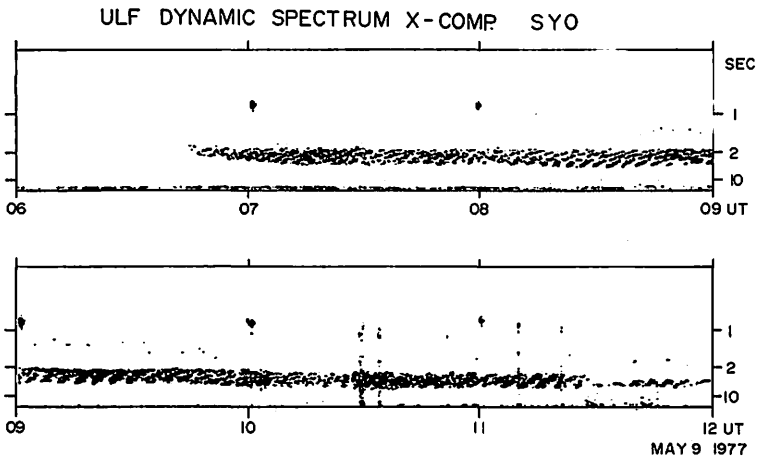

Fig. 6. Dynamic spectrum of Pc 1 event observed at Syowa on May 9, 1977. Fan structures vary with time in the spectra.

### 5. Global appearance of Pc 1 events

Although Memambetsu is located far from Syowa Station in both latitude and longitude, several Pc 1 events were observed simultaneously at these two stations during the period from February 17, 1977 to January 31, 1978. One example of them is shown in Fig. 7. At Memambetsu, PP was observed during the interval of 1238-1353 UT on April 22, 1977, while at Syowa, PP was also observed during the interval of 1210-1350 UT. However, the mean and repeating periods at Memambetsu are markedly different from those at Syowa. At Memambetsu, the mean period is  $\sim 1.5$  sec and does not vary during the event occurrence. On the other hand, at Syowa, the mean period is gradually increased from  $\sim 2.3$  sec to  $\sim 2.9$  sec. Difference in the mean period between the low-latitude PP and the high-latitude one is clearly found in this example. Consequently, the repeating period is much shorter at Memambetsu than at Syowa as shown in Fig. 7.

It has been previously found that short-period pulsations are often associated with sudden commencements (sc) of magnetic storms or sudden impulses (si). As shown in Fig. 8, sudden H-component increase (si) starts at about 1225 UT on November 25, 1977 at Kakioka. In coincident with the onset of si, a Pc 1 event suddenly appeared at Memambetsu. On the other hand, at high-latitude station Syowa, si-associated Pc 1 event started several minutes after the onset of si. It is noteworthy that

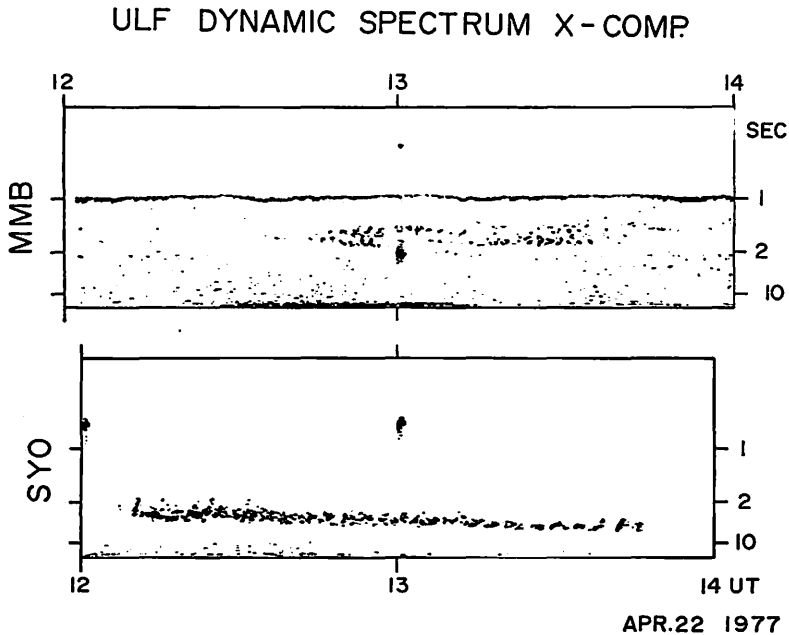

Fig. 7. Simultaneous appearance of pearl pulsation type of Pc 1 events at a low-latitude (Memambetsu) and a high-latitude (Syowa). Mean and repeating periods at Memambetsu are distinctly shorter than those at Syowa.

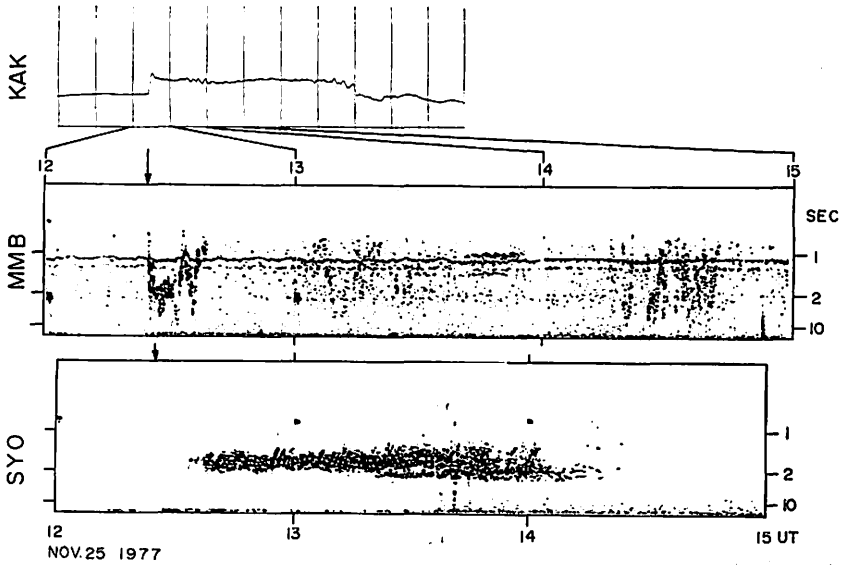

Fig. 8. Dynamic spectra of si-associated Pc 1 events observed Memambetsu and Syowa. The start of the Pc 1 was several minutes after the onset of si at Syowa.

when si-associated Pc 1 started at Syowa, the si-associated one at Memambetsu rapidly diminished ( $\sim 1235$  UT), while when the si-associated Pc 1 at Syowa diminished, Pc 1 at Memambetsu was activated again ( $\sim 1420$  UT). The si-associated Pc 1 at Memambetsu showed burst-like structure and did not show any fan-like one like as PP. The si-associated Pc 1 at Syowa did also not show any fan-like structure, either. The Pc 1 mean period at Syowa was  $\sim 1.5$  sec and was somewhat shorter than that generally observed at high latitudes. This fact may be related to si effect (compression of the magnetosphere). An examination of sc (si) effects for Pc 1 events may present useful information concerning their generation mechanism.

#### 6. Comparison of statistical features of Pc 1 events between low and high-latitudes—frequency of occurrence

As was mentioned in Section 1, many different types of diurnal variation of frequency of occurrence have been proposed for Pc 1 event. However, the above-mentioned confusion could be arisen from differences in observing apparatus and analyzing intervals. It is necessary to obtain data by means of similar observing apparatus and analyze them in common intervals for a comparison of Pc 1 characteristics between low- and high-latitudes. As mentioned in Section 2, concurrent observations of magnetic pulsations were performed at Syowa Station in Antarctica and at Memambetsu in Japan during the period from February, 1977 to January, 1978. Observing apparatuses used at the two stations are shown in Fig. 2. Consequently, the expected period characteristics in the Pc 1 range are also similar at the two stations as shown in Fig. 3.



A comparison of the statistical features of Pc 1 events between the low- and high-latitudes will first be made in regard to frequency of occurrence. Though several kinds of Pc 1 have been reported (pearl pulsation, hydromagnetic chorus, continuous emission and sweeper), they are considered to belong to one group, Pc 1, in the present analysis. To study the diurnal variation of the Pc 1 occurrence frequency, we count hourly numbers of 20-minute periods in which any Pc 1 event appears. The appearance of the event is verified by means of both dynamic spectral diagram and monitoring pen-chart records. The total numbers counted are 595 at Memambetsu and 2509 at Syowa during the period of February 12, 1977 to January 31, 1978. They are summarized as a function of local time at Memambetsu, while as a function of magnetic local time at Syowa, and illustrated in Figs. 9(a) and (b). At

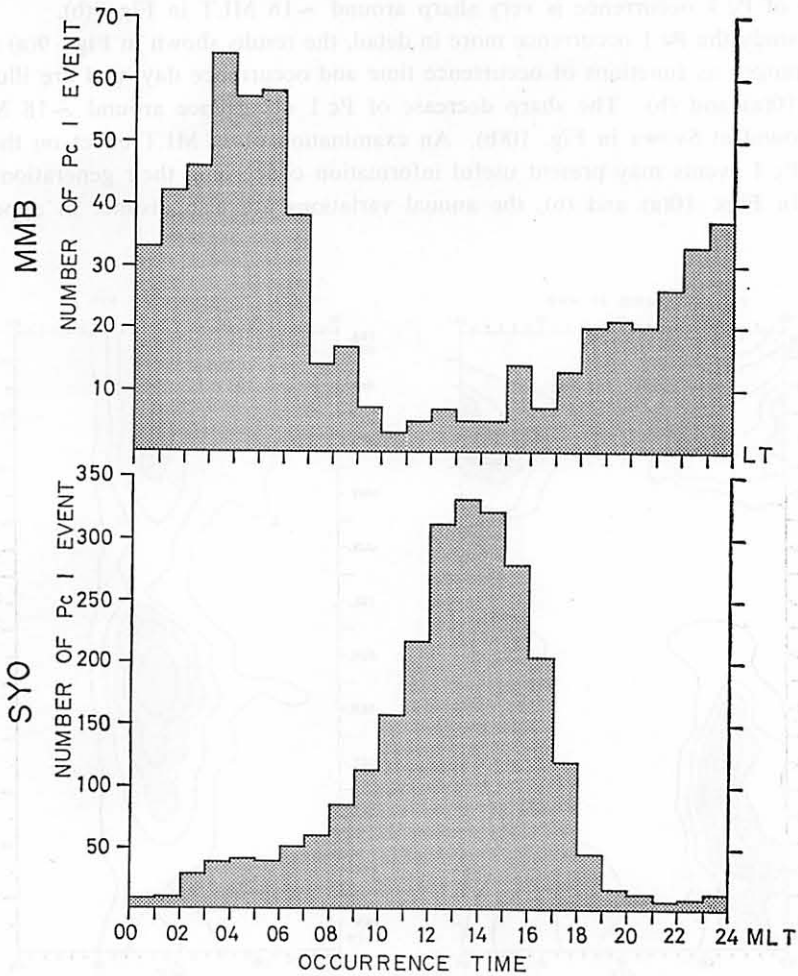

Fig. 9. Diurnal variations in frequency of occurrence of Pc 1 events at Memambetsu (a) and at Syowa (b).

Memambetsu (Fig. 9(a)), Pc 1 occurrence concentrates in the night hours. The occurrence frequency has a very distinct maximum at one or two hours before sunrise ( $\sim 04$  LT). Then, it decreases rapidly and reaches a minimum around noon. It usually shows a comparatively low level in the daytime, increasing gradually after sunset. The above-mentioned tendencies are almost content with the results by Kawamura (1970).

Contrary to the results at the low-latitude, Pc 1 occurrence concentrates in the day hours at Syowa (Fig. 9(a)). The occurrence frequency has a very distinct maximum at about one hour after magnetic local noon ( $\sim 13$  MLT). This result is also consistent with that by Heacock and Hessler (1962) and by Kokubun and Oguti (1968). Then, it decreases with time and reaches a minimum around magnetic local midnight. It usually shows a comparatively low level in the nighttime. It seems that the decrease of Pc 1 occurrence is very sharp around  $\sim 18$  MLT in Fig. 9(b).

To study the Pc 1 occurrence more in detail, the results shown in Figs. 9(a) and (b) are rearranged as functions of occurrence time and occurrence day, and are illustrated in Figs. 10(a) and (b). The sharp decrease of Pc 1 occurrence around  $\sim 18$  MLT is clearly found at Syowa in Fig. 10(b). An examination of 18 MLT effect on the high-latitude Pc 1 events may present useful information concerning their generation mechanism. In Figs. 10(a) and (b), the annual variations are also distinct in appearance

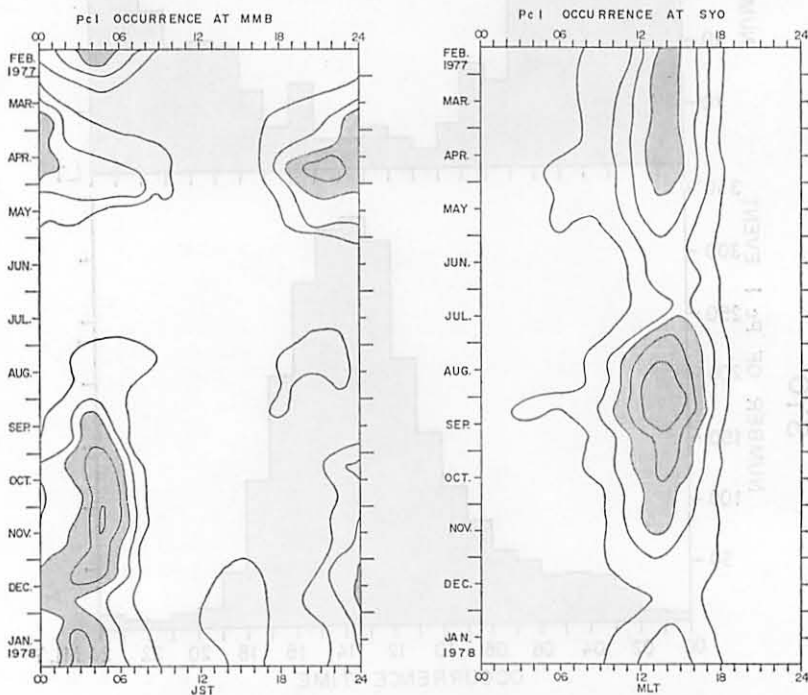

Fig. 10. Diurnal and seasonal variations in frequency of occurrence of Pc 1 events at Memambetsu (a) and at Syowa (b).

at both Memambetsu and Syowa. However, they are not similar at these two stations. At Memambetsu, Pc 1 events were only a few in summer and have the maximum of occurrence frequency in the winter months. At Syowa, Pc 1 events were most frequently observed at spring (around September) and autumn (around March) equinoxes. These tendencies will be discussed in some detail in Section 8.

As mentioned in Sections 3-5, Pc 1 mean periods at the low-latitude are somewhat shorter than those at the high-latitude. In order to study that tendency statistically, mean periods were read at every 20 minute for the events shown in Figs. 9 and 10, and the results are summarized in Figs. 11(a) and (b). At Memambetsu, Pc 1 event has an occurrence peak around 0.88 Hz (1.2-1.3 sec), while, at Syowa, its peak is around 0.4-0.3 Hz (2.5-3 sec). The differences of mean periods between low- and

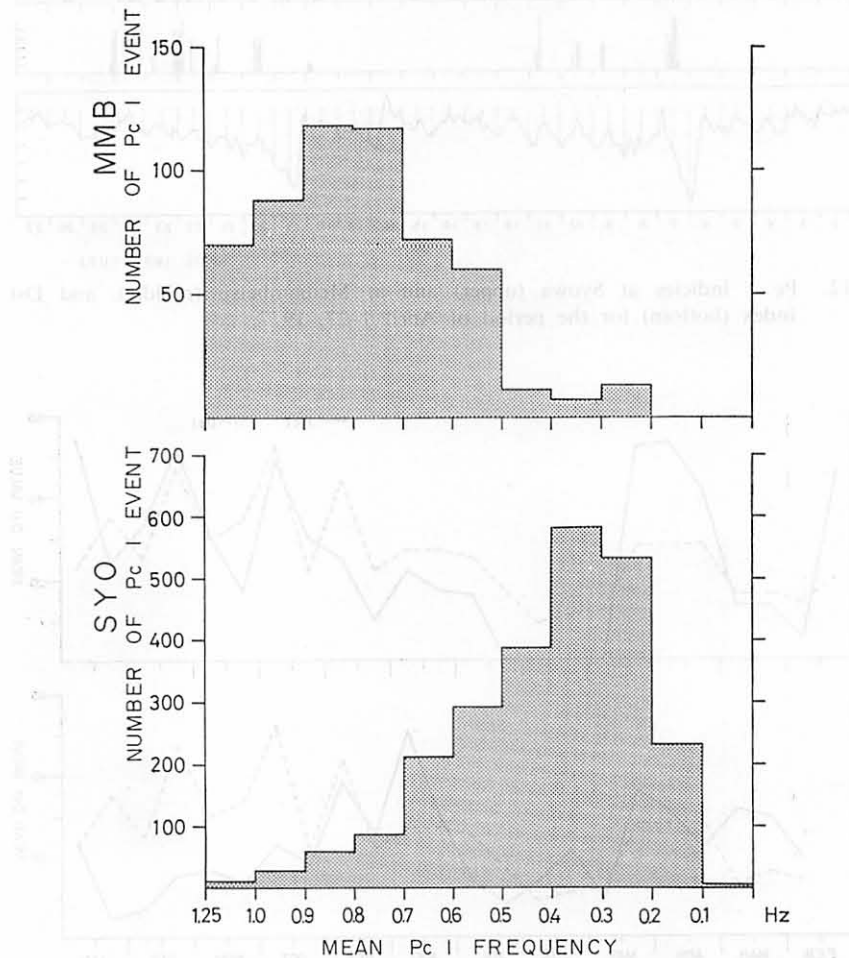

Fig. 11. Histograms of occurrence frequency of Pc 1 events as a function of the observed mean frequency, at Memambetsu (a) and at Syowa (b).

high-latitudes are found statistically from the results shown in Figs. 11(a) and (b).

**7. Comparison of statistical features of Pc 1 events between low- and high-latitudes—dependence on general geomagnetic activity**

According to the results by Kawamura (1970), the low-latitude Pc 1 occurrence usually continues over a few successive days in a calm period following a rather large magnetic storm. However, any quantitative relation between the Pc 1 activity

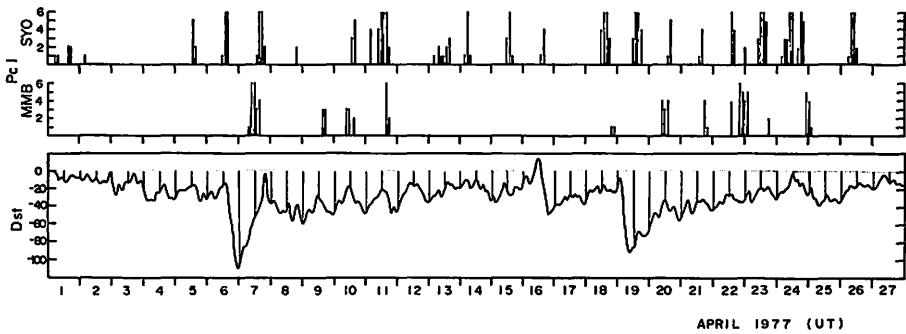

Fig. 12. Pc 1 indices at Syowa (upper) and at Memambetsu (middle), and Dst index (bottom) for the period of April 1-27, 1977.

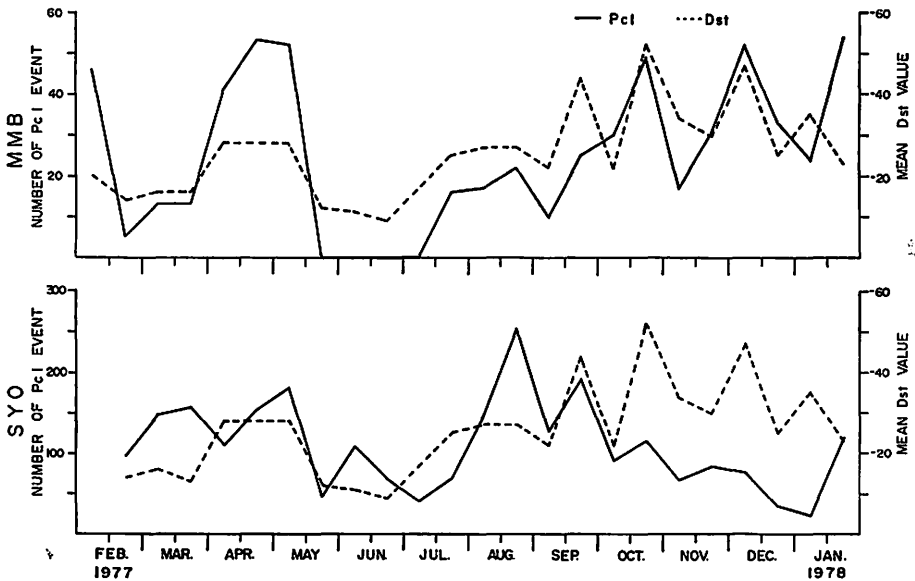

Fig. 13. (a) The variations of the number counted of Pc 1 events (solid line) and half-monthly mean Dst index (dashed line).

and other geomagnetic phenomena has not yet been clarified. In order to examine the relation between the Pc 1 activity and general geomagnetic activity, Pc 1 index was defined by the following procedure. All Pc 1-type phenomena are registered by means of both dynamic spectral diagram and pen-chart records. Then, an appearance of Pc 1 event is counted at every 20-minute period and a Pc 1 index is constructed by summing those obtained at every two-hour interval so that the index takes values from 0 to 6. The Pc 1 index has been constructed for the period of April 1-27, 1977 and are examined in relation to the Dst and Kp indices.

In Fig. 12, we show plots of Pc 1 indices at Syowa (upper part) and at Memambetsu (middle part) as well as Dst index (bottom part). As is well known, Dst index shows the extent of the ring current development (magnitude of geomagnetic storm). In Fig. 12, we can find the clear relation that low-latitude Pc 1 events are generally

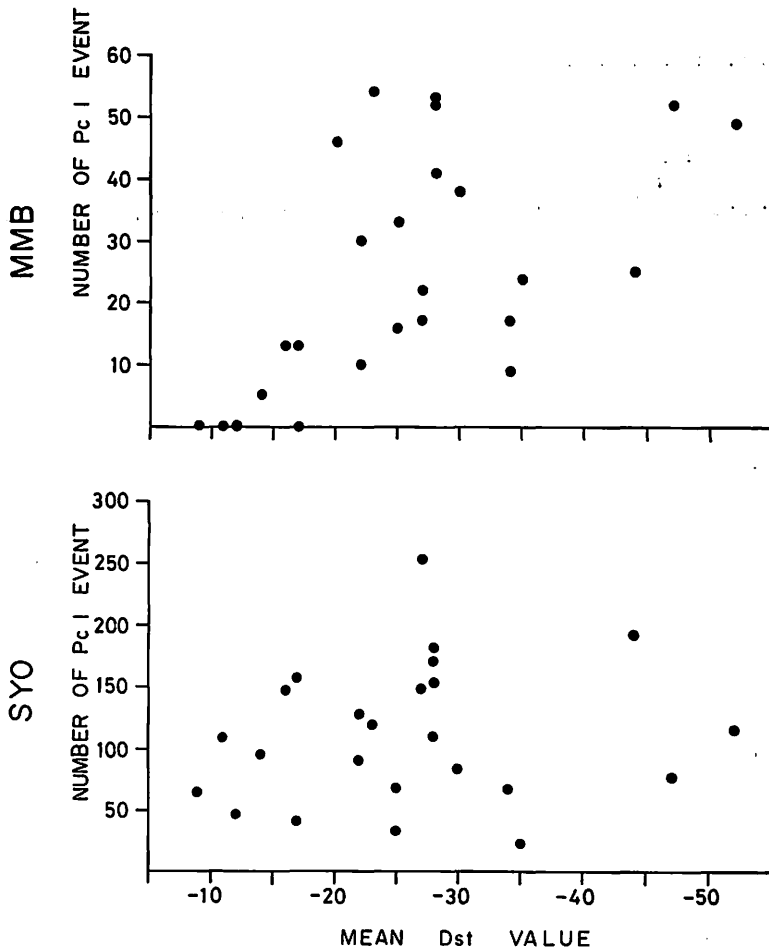

Fig. 13. (b) Number counted of Pc 1 events is plotted as a function of half-monthly mean Dst index.

observed over a few successive days in the recovery phase of a geomagnetic storm. However, we cannot find any clear relation between the Pc 1 index at the high-latitude and the Dst index. In order to examine the relation of the Pc 1 occurrence with the development of the ring current more statistically, we plot these two indices for the period of February, 1977-January, 1978 and illustrate them in Fig. 13(a). In the figure, the Pc 1 index is summed at every half month, while the Dst index is averaged at every half month. A clear correlation between the Pc 1 index and the Dst one is found at Memambetsu, however any clear correlation cannot be found at Syowa. These tendencies are found in Fig. 13(b) more distinctly. In the figure, the number of Pc 1

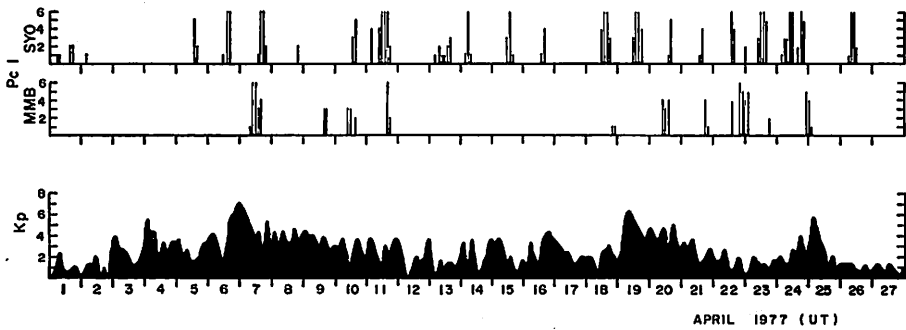

Fig. 14. Pc 1 indices at Syowa (upper) and at Memambetsu (middle), and Kp index (bottom) for the period of April 1-27, 1977.

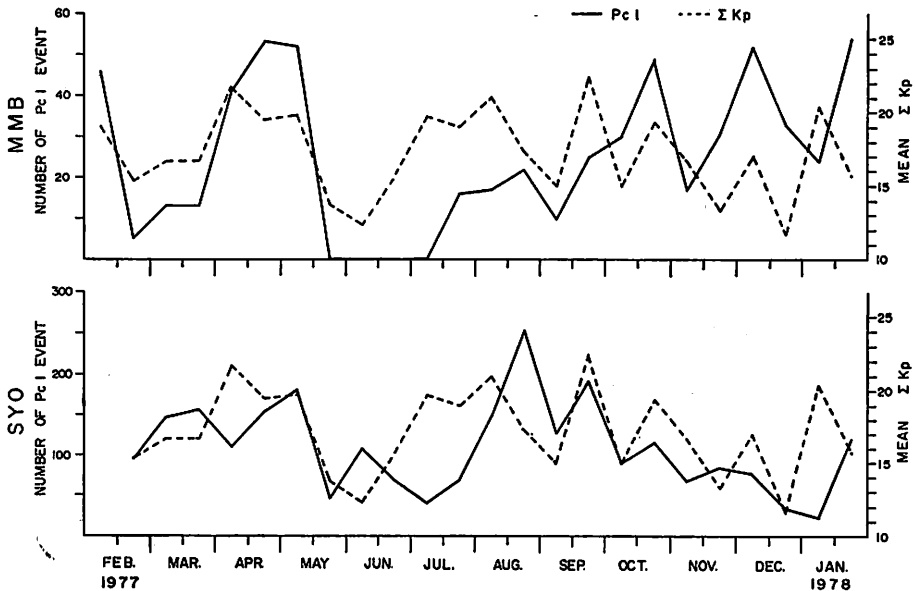

Fig. 15. (a) The variations of the number counted of Pc 1 events (solid line) and half-monthly mean  $\Sigma Kp$  index (dashed line).

events counted at every half month are plotted as a function of mean Dst values averaged at every half month. At low-latitudes, Pc 1 events are observed more frequently associated with large a magnetic storm. On the other hand at high-latitudes, occurrence of Pc 1 events are not controlled by the magnitude of a magnetic storm.

In Fig. 14, we show the plots of Pc 1 indices at Syowa (upper part) and at Memambetsu (middle part) as well as Kp index (bottom part). In the figure, it seems that some correlations exist between the high-latitude Pc 1 index and the Kp one. In order to further examine the above-mentioned tendencies, we plot these two indices for the period of February, 1977-January, 1978 and illustrate them in Fig. 15(a). In the figure, the Pc 1 index is summed at every half month, while the Kp index is averaged at every half month. A relatively clear correlation between the Pc 1 index and the

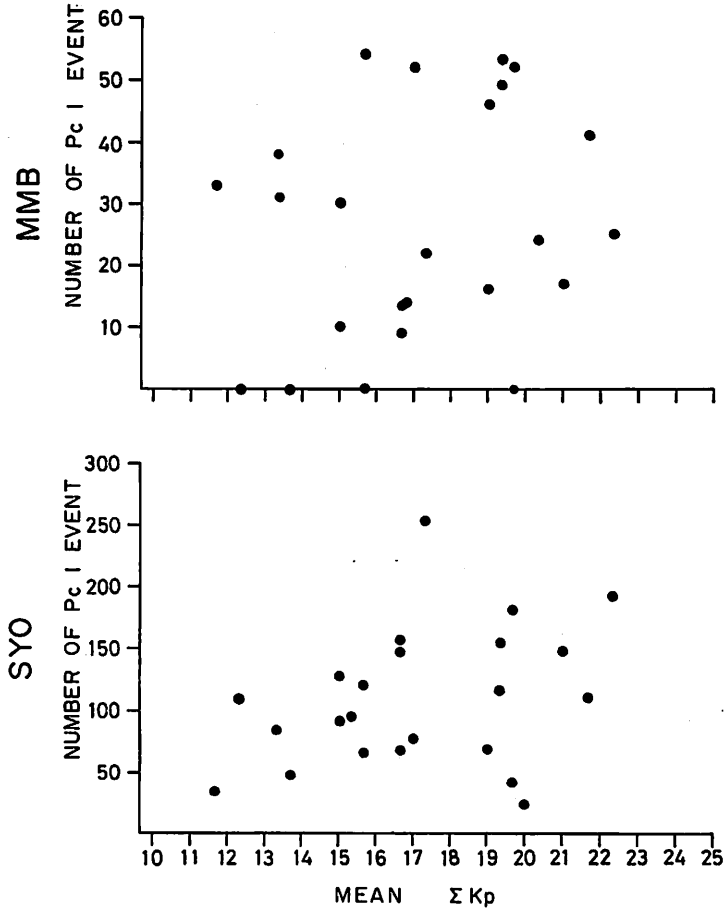

Fig. 15. (b) Number counted of Pc 1 events is plotted as a function of half-monthly mean  $\Sigma Kp$  index.

Kp one is found at Syowa, however any clear correlation cannot be found at Memambetsu. These tendencies are found in Fig. 15(b) more distinctly. In the figure, the numbers of Pc 1 events counted at every half month are plotted as a function of mean Kp values averaged at every half month. At high-latitudes, Pc 1 events are observed more frequently in magnetically disturbed conditions.

The low-latitude Pc 1 is different from the high-latitude one in its dependency on magnetic activities.

## 8. Discussion

Though Pc 1 pulsations have been analyzed by many research workers, their global characteristics have not yet been clarified. Especially, the relation between the low-latitude Pc 1 and the high-latitude one has not yet been studied sufficiently. Our purpose is to clarify that problem and we have studied Pc 1 pulsations in Sections 3-7 on the basis of the data obtained at Memambetsu and Syowa. Several differences have been found between low-latitude Pc 1 events and high-latitude ones. They are as follows:

(1) At the low-latitude, Pc 1 occurrence concentrates in the night hours and has a maximum at one or two hours before sunrise ( $\sim 04$  LT). On the other hand, at the high-latitude, Pc 1 occurrence concentrates in the day hours and has a maximum at about one hour after magnetic local noon ( $\sim 13$  MLT).

(2) Concerning the period of February, 1977-January, 1978, Pc 1 events were most frequently observed in winter time and were rarely observed in summer time at the low-latitude, while they were most frequently observed at equinox times at the high-latitude.

(3) Pc 1 mean and repeating periods observed at the low-latitude are distinctly shorter than those observed at the high-latitude. Averaged mean periods are 1.2-1.3 sec at Memambetsu and 2.5-3 sec at Syowa.

(4) Low-latitude Pc 1 events are well correlated with the development of the ring current and are usually observed over a few successive days in the recovery phase of a large geomagnetic storm.

(5) High-latitude Pc 1 events are somewhat correlated with Kp values.

The low-latitude Pc 1 events are considered to be propagated through a duct near the ionospheric F layer from higher latitudes (Tepley and Landshoff, 1966; Manchester, 1966). In the duct propagation, hydromagnetic waves should be suffered some attenuations by absorptions. The attenuations will increase with the increasing of the electron density in the ionosphere. Therefore, the low-latitude Pc 1 events take place most frequently in the nighttime and winter time due to the small duct attenuations resulted from the small electron density. On the other hand, the daytime maximum of the high-latitude Pc 1 events is not explained by the ionospheric duct propagation. In high-latitudes, field lines anchored at that region are closed in the magnetosphere in the daytime, while they are blown out in the magnetospheric tail in the nighttime. These magnetic field configurations seem to cause the daytime maximum at high-latitudes. For the sharp decrease of the high-latitude Pc 1 occurrence around 18 MLT shown in Fig. 10(b), we have not any model at the present stage. This problem will be ex-



amined in our subsequent papers.

In relation to the mechanism of the exciting of Pc 1 waves, the following ion-cyclotron instability model was proposed by Cornwall (1965) and Jacobs and Watanabe (1966). In cases where a beam velocity of trapped protons is supersonic with respect to the local Alfvén velocity, hydromagnetic waves are emitted at a frequency corresponding to the occurrence of the cyclotron instability. These hydromagnetic waves bounce along the field lines between the conjugate ionospheres. When a wave packet passes through the proton beam, within each sequence it gains energy from the particles owing to the instability. According to the results of (4), low-latitude Pc 1 events will be related with the cyclotron interaction between ring-current protons and hydromagnetic waves. However, the position of the ring-current is usually  $\sim 5$ -6 earth radius and is inside of the position where the line of force anchored at the auroral region intersects the equatorial plane in the magnetosphere (7-8 earth radius). It is difficult to consider the ring-current protons to be a cause of the high-latitude Pc 1 event. Therefore, the low-latitude Pc 1 shows a good correlation to Dst values, whereas the high-latitude one doesn't. The low-latitude Pc 1 events are frequently observed in the recovery phase of a geomagnetic storm. It seems that the ring-current is decreased by a transfer of particle energies to hydromagnetic waves.

On the other hand, the high-latitude Pc 1 index shows a somewhat good correlation with Kp as shown in Figs. 15(a) and (b). At high-latitudes, Pc 1 events are frequently observed at geomagnetically disturbed conditions. In general, geomagnetic disturbance conditions are most activated at equinox times. The equinox maximum of Pc 1 occurrence at the high-latitude shown in Fig. 10(b) should be related to the Kp dependence shown in Figs. 10(a) and (b).

Another important result is the difference of Pc 1 mean period, consequently repeating period, between high- and low-latitudes. Pc 1 repeating period should correspond to the bounce period of the hydromagnetic waves along the geomagnetic field line between the two conjugate ionosphere. Therefore, it should be proportional to the length of field lines. Pc 1 mean period should intimately relate to the proton cyclotron frequency. Therefore it should be inversely proportional to the strength of the ambient magnetic field. If a Pc 1 source region is located further earthward in the magnetosphere, we will expect a shorter Pc 1 repeating period, consequently a shorter Pc 1 mean period on the ground. The results shown in Figs. 11(a) and (b) suggest that the source region associated with the low-latitude Pc 1 events is located further earthward in the magnetosphere than that associated with the high-latitude Pc 1 events. According to Sakurai (1975), the equatorial position of the propagation path of hydromagnetic waves can be calculated by means of repeating periods and the lower and the higher frequency of the rising tone. We will try that procedure to examine the difference of Pc 1 source region between high- and low-latitudes, quantitatively, in a future work.

Tepley, Heacock and Fraser (1965) found a Pc 1 event whose mean period is constant from Alaska through New Zealand. However, we think that such a case is rare. Our present statistical results suggest that the source region associated with the low-latitude Pc 1 event is different from that associated with the high-latitude one

and that the former is located further earthward in the magnetosphere than the latter.

### References

- Benioff, H. (1960): Observations of geomagnetic fluctuations in the period range 0.3 to 120 seconds, *J. Geophys. Res.*, **65**, 1413.
- Cornwall, J. M. (1965): Cyclotron instabilities and electromagnetic emission in the ultra low frequency and very low frequency ranges, *J. Geophys. Res.*, **70**, 61.
- Heacock, R. R. and V. P. Hessler (1962): Pearl-type telluric current micropulsations at College, *J. Geophys. Res.*, **67**, 3985.
- Heacock, R. R. and V. P. Hessler (1965): Pearl-type micropulsations associated with magnetic storm sudden commencements, *J. Geophys. Res.*, **70**, 1103.
- Jacobs, J. A. and T. Watanabe (1966): Amplification of hydromagnetic waves in the magnetosphere by a cyclotron instability process with applications to the theory of hydromagnetic whistlers, *J. Atmospheric Sci.*, **28**, 235.
- Kato, Y. and T. Saito (1964): Observation of Pc 1 and Pi 1 by a visual type induction magnetometer at middle latitude station, Onagawa, *Rep. Ionos. Space Res. Japan*, **18**, 188.
- Kawamura, M. (1970): Short-period geomagnetic micropulsations with period of about 1 second in the middle and low latitudes, *Geophys. Mag.*, **35**, 1.
- Kawamura, M. (1977): Preliminary report of magnetic pulsations during January-June 1976, published by the Kakioka Magnetic Observatory.
- Kawamura, M. and M. Kuwashima (1977): On the geomagnetic pulsation pc (Part II), Middle- and low-latitude pc-3, *Mem. Kakioka Mag. Obs.*, **17**, 7.
- Kokubun, S. (1970): Fine structure of ULF emissions in the frequency range of 0.1~2 Hz, *Rep. Ionos. Space Res. Jpn.*, **24**, 24.
- Kokubun, S. and T. Oguti (1968): Hydromagnetic emissions associated with storm sudden commencements, *Rep. Ionos. Space Res. Jpn.*, **22**, 45.
- Kuwashima, M. (1978): Wave characteristics of magnetic Pi 2 pulsations in the auroral region—Spectral and polarization studies, *Memoirs of National Institute of Polar Research Series A Aeronomy No. 15*.
- Manchester, R. N. (1966): Propagation of pc 1 micropulsations from high to low latitudes, *J. Geophys. Res.*, **71**, 3749.
- Saito, T. (1960): Period analysis of geomagnetic pulsations by a sona-graph method, *Sci. Rep. Tohoku Univ., Ser. 5, Geophys.*, **12**, 105.
- Saito, T. (1969): Geomagnetic pulsations, *Space Sci. Rev.*, **10**, 319.
- Sakurai, T. (1975): Variations of magnetospheric convection electric fields during substorms as inferred from Pc 1 hydromagnetic waves, *Planet. Space Sci.*, **23**, 611.
- Schlich, R. (1963): Micropulsations de periodes comprise entre 0.5 et 6 s observées dans les regions de hautes et moyennes latitudes, *Ann. Geophys.*, **19**, 347.
- Tepley, L. R. and R. K. Landshoff (1966): Waveguide theory for ionospheric propagation of hydromagnetic emissions, *J. Geophys. Res.*, **71**, 1499.
- Tepley, L. R., R. R. Heacock and B. J. Fraser (1965): Hydromagnetic emissions (Pc 1) observed simultaneously in the auroral zone and at low latitudes, *J. Geophys. Res.*, **70**, 2720.
- Troitskaya, V. A. (1967): Micropulsations and the state of the magnetosphere, in *Solar-Terrestrial Physics* (ed. by J. W. King and W. S. Newman), Academic Press, pp. 213-274.

## 低緯度および高緯度における Pc 1 脈動の特性の対比

外 谷 健・桑 島 正 幸・河 村 譜  
(地磁気観測所)

福 西 浩・鮎 川 勝  
(国立極地研究所)

### 概 要

1977年2月から1978年1月の期間に中低緯度(女満別)と高緯度(南極, 昭和基地)において, 誘導磁力計を用いて観測された Pc 1 について, その特性の比較を統計的に試みた。その結果, 両者には出現頻度の日変化, 中心周期および地磁気活動度の依存性において大きな差異が認められ, 発生機構が異なることが推察される。